

**NITTAN**

ST-H-AS SENSORTEC
ANALOGUE-ADDRESSABLE
HEAT SENSOR
INSTRUCTION MANUAL

No: **NISM/STHA/03**DATE: **MARCH 2001**PAGE:
1 of 6ISSUE:
03

*From world leaders in **SENSOR TECHNOLOGY**
comes **SENSORTEC.....***

*The new **ST-H-AS** analogue addressable smoke sensor forms part of a brand new range of analogue addressable fire detectors from Nittan (UK) Ltd called **SENSORTEC-ANALOGUE**.*

*The **ST-H-AS** together with the **ST-I-AS** and **ST-P-AS** are all low cost, elegantly designed, low profile fire sensors which are aesthetically pleasing, thus enabling them to blend unobtrusively into modern working environments.*

*The **SENSORTEC** analogue addressable range all feature the very latest technological advancements increasing reliability and performance are all compatible with our existing 'AS' protocol and are compatible with leading analogue addressable panel manufacturers.*

SENSORTEC-ANALOGUE.....

**NITTAN**

**ST-H-AS SENSORTEC
ANALOGUE-ADDRESSABLE
HEAT SENSOR
INSTRUCTION MANUAL**

No: **NISM/STHA/03**DATE: **MARCH 2001**PAGE:
2 of 6ISSUE:
03**CONTENTS:-**

Section 1	- Introduction	- Page 1
Section 2	- Sensor Models	- Page 3
Section 3	- Base Models	- Page 3
Section 4	- Installation	- Page 3
Section 5	- Maintenance & Cleaning	- Page 3
Section 6	- Specifications	- Page 4
Section 7	- Environment Parameters:-	- Page 4
	- Temperature	- Page 4
	- Humidity	- Page 4
Section 8	- EMC	- Page 4
Section 9	- Sensitivity	- Page 4
Section 10	- Address Setting	- Page 5
Section 11	- Dimensions	- Page 6

Section 1 - INTRODUCTION

The ST-H-AS is an attractively-styled, low cost, low profile heat sensor for use with Nittan 'AS' protocol control panels. This sensor is identical in function to our TCA-AS/TCA-AS2LR sensor and can therefore be used as a direct replacement.

ST-H-AS features:

- * Low profile, stylish appearance**
- * Low monitoring current**
- * Integral LED fire alarm indicator**
- * Remote indicator output on standard models**
- * Compatible with RB-3/RB-6 Bases**
- * Compatible with existing 'AS' protocol**

**NITTAN**

ST-H-AS SENSORTEC
ANALOGUE-ADDRESSABLE
HEAT SENSOR
INSTRUCTION MANUAL

No: **NISM/STHA/03**DATE: **MARCH 2001**PAGE: **3 of 6**ISSUE: **03**

Section 2 - SENSOR MODELS

The ST-H-AS heat sensor is supplied, as standard, with three terminals.

The ST-H-AS has the facility to activate a remote LED indicator or auxiliary function, as standard.

The terminals on the ST-H-AS sensor head are configured as follows:-

Terminal 3 = -VE 3 mA aux output

Terminal 1 = Sig + (+VE) positive in/out

Terminal 6 = S- (-VE) negative in/out

Section 3 - BASE MODELS

STB-4 Base: having 4 terminals, for standard use with ST-P-AS sensor including the auxiliary output function.

Section 4 - INSTALLATION

In normal use, the ST-H-AS heat sensor will be installed at ceiling level. Pass the field wiring through the cable hole in the centre and from the rear of the base. Offer up and affix the base to the ceiling or conduit fitting with screws via the base mounting holes. Consider visibility and orientation of the sensor's integral alarm LED indicator when mounting the base. Connect the field wiring to the base terminals, as detailed on page 5 making sure the wiring does not obstruct fitting of the sensor head. Fit the heat sensor head by inserting it into the base and turning clockwise until the notch in the sensor's rim aligns with base locking screw.

Section 5 - MAINTENANCE AND CLEANING

Maintenance & Servicing:

Generally, it should not be necessary to dismantle the heat sensor since there is no internal chamber which may require cleaning. The heat sensing element and holder may be kept clean by gentle brushing with a clean, dry, soft brush for dry deposits. For sticky deposits, the brush may be moistened with a little alcohol. If the plastic outer cover becomes dirty, this may be removed and cleaned in the same manner as described above for the outer covers of smoke sensors. When replacing this cover, make sure that the led indicator locates properly in the hole in the outer cover before pushing the outer cover home, otherwise the led will become damaged.

Servicing of the system should be carried out in accordance with the requirements of BS 5839 Part 1, Fire Detection and Alarm Systems for Buildings: Code of Practice for System Design, Installation and Servicing.

The maintenance procedures described below should be conducted with the following frequency:

One month after installation:- Routine Inspection and every 3 months after.

Every 6 months:- Operational Test

Every 12 months:- Functional clean and Test

All above frequencies of maintenance are dependent on ambient conditions.

Routine Inspection

i) Ensure the sensor head is secure and undamaged.

ii) Ensure the surface of the sensor's outer cover is clean. If there are deposits due to the presence of oil vapour, dust etc, then the sensor should be cleaned in accordance with the cleaning instructions detailed later in this manual. It may be advisable to ensure that such cleaning is conducted regularly in the future.

iii) Ensure no equipment which may generate high temperatures has been installed in the vicinity of the sensor since the last routine inspection. If such equipment has been installed, then you should notify the Fire Safety Officer or other competent authority that it's presence may cause false alarms.

Operational Test

The purpose of the Operational Test is to confirm the sensor's correct operation in response to a heat condition.

i) Take any necessary precautions at the control panel to limit the sounding of the alarm sounders/bells and any fire service summoning device.

ii) Introduce heat using a heat gun/hair dryer which has been designed especially for testing heat sensors.

iii) After the heat sensor has given the alarm condition, reset the sensor from the control panel. It may be necessary to allow a short time to elapse before resetting the sensor, to allow any residual heat from the test, to disperse.

Functional Tests:-

The ST-H-AS may be tested on the TT3 or TT4* transmission tester, please refer to the instruction manual for the testers as follows:-

TT3 = NISM/TT3/01 April 1993

TT4 = *Available early 1998



NITTAN

**ST-H-AS SENSORTEC
ANALOGUE-ADDRESSABLE
HEAT SENSOR
INSTRUCTION MANUAL**

No: NISM/STHA/03	
DATE: MARCH 2001	
PAGE: 4 of 6	ISSUE: 03

Ultrasonic Cleaning

This method may be used to good effect for the removal of contamination from the outer cover only, after they have been dismantled from the sensor. However, care must be taken in selection of the solvent so as not to cause damage to the plastic and insect screen. The solvent supplier should be consulted as to its suitability.

Under no circumstances should the fully assembled heat sensor be cleaned without disassembly as this may cause damage to the special treatment applied to specific components within the sensor.

Section 6 - SPECIFICATION

Model Reference:	-	ST-H-AS
Computer Reference:	-	81200
Sensor Type:		Low mass thermistor
Operating Current:	-	200µamps fire alarm (LED on) 3.2mA
Signal Current:	-	50mA nominal
Sensitivity:	-	BS5445/EN54 Part 5 Grades 1, 2, 3. BS5445/EN54 Part 8 Range 1.
Mass:	-	101g (excluding base)
Charging Time:	-	20 seconds
Ambient Temperature Range:	-	-10 deg.C to +50 deg.C

Section 7 - ENVIRONMENTAL PARAMETERS

Temperature Considerations:
Over the range from -10 Deg. C. to +50 Deg. C..

Humidity:
Relative Humidity of up to 90%, measured at 50 deg. C., non condensing.

Section 8 - EMC

Installation
The installation shall be in accordance with the regulations either of the approval body for an approved system, or otherwise, to the national code of practice/regulations for the installation of the fire alarm system, e.g. BS 5839 part 1.

Electromagnetic Compatibility (EMC)

On a site where there is an unusually high level of potential electrical interference, e.g. where heavy currents are being switched or where high levels of R.F. are prevalent, care then must be taken in the type and routing of cables. Particular care should be given to the separation of zone wiring from the cable carrying the interference.

Section 9 - SENSITIVITY/THRESHOLDS

Heat Sensor Performance Graphs:-

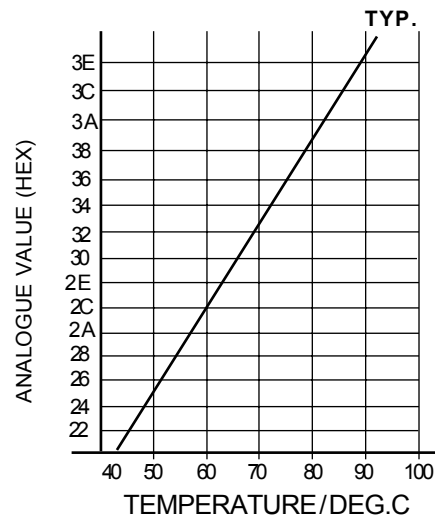
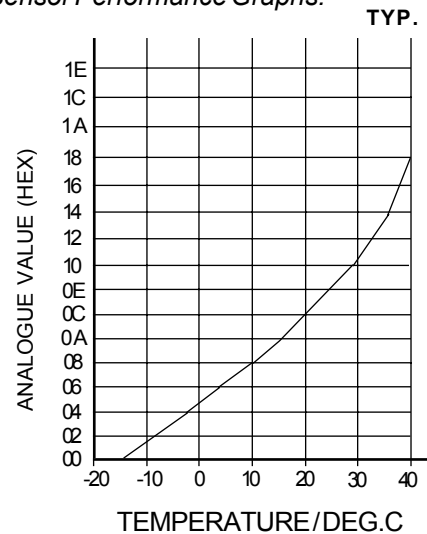

Performance Grade to BS 5445 Part 5 (EN 54 Part 5):-

Grade 1 (nominal 58 degrees C)	2A
Grade 2 (nominal 66 degrees C)	30
Grade 3 (nominal 74 degrees C)	35

Performance Range to BS 5445 Part 8 (EN 54 Part 8):-

Range 1 (nominal 80 degrees C)	3A
Fault (all Sensitivities):	00



**ST-H-AS SENSORTEC
ANALOGUE-ADDRESSABLE
HEAT SENSOR
INSTRUCTION MANUAL**

No: NISM/STHA/03	
DATE: MARCH 2001	
PAGE: 5 of 6	ISSUE: 03

Section 10 - ADDRESS SETTING:-

NITTAN DIL SWITCH SETTINGS FOR SENSORTEC MODEL TYPES: ST-I-AS, 5000/ION ST-P-AS, 5000/OP, ST-H-AS, 5000/TEMP.

WARNING: Connect only to **NITTAN (UK) LTD** suitable and compatible analogue-addressable control panels. If in doubt, check with control panel manufacturer.

DIL SWITCH SETTINGS - ALL SENSOR MODELS

Hold the sensor so that the product label can be correctly read. Set each digit on the appropriate eight switches according to the address required.



Rear of ST-H-AS Sensor and Address Switch Setting (DIL Switch)

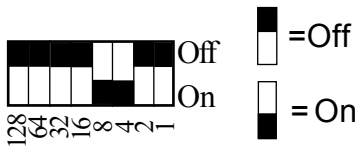

Above switch setting set to address 12.

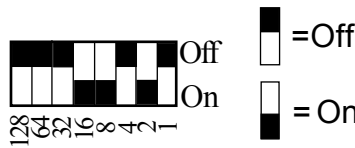

Above switch setting set to address 26.

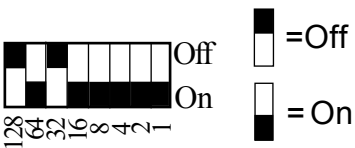

Above switch setting set to address 95.

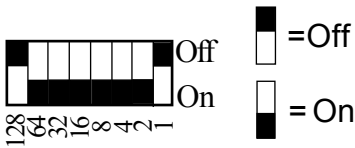

Above switch setting set to address 126.



NITTAN

ST-H-AS SENSORTEC
ANALOGUE-ADDRESSABLE
HEAT SENSOR
INSTRUCTION MANUAL

No: **NISM/STHA/03**

DATE: **MARCH 2001**

PAGE: **6 of 6**

ISSUE: **03**

Section 9 - CONNECTIONS (Also suitable for ST-I/ST-P-AS smoke sensors)

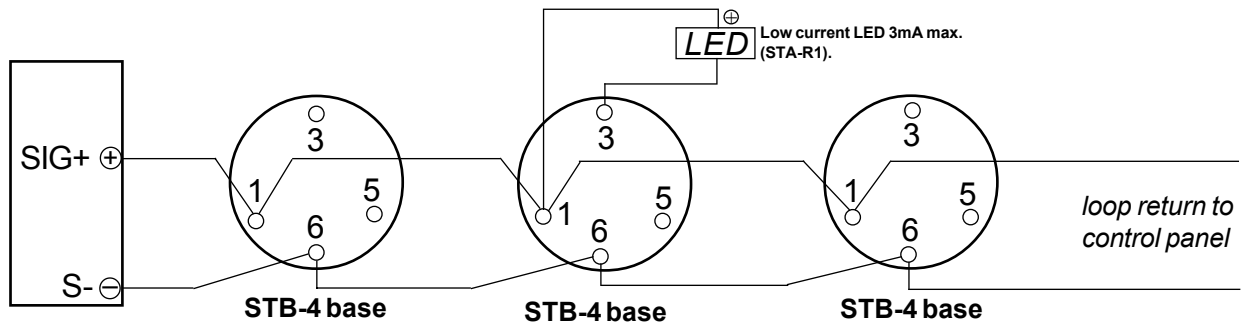

Section 10 - DIMENSIONS

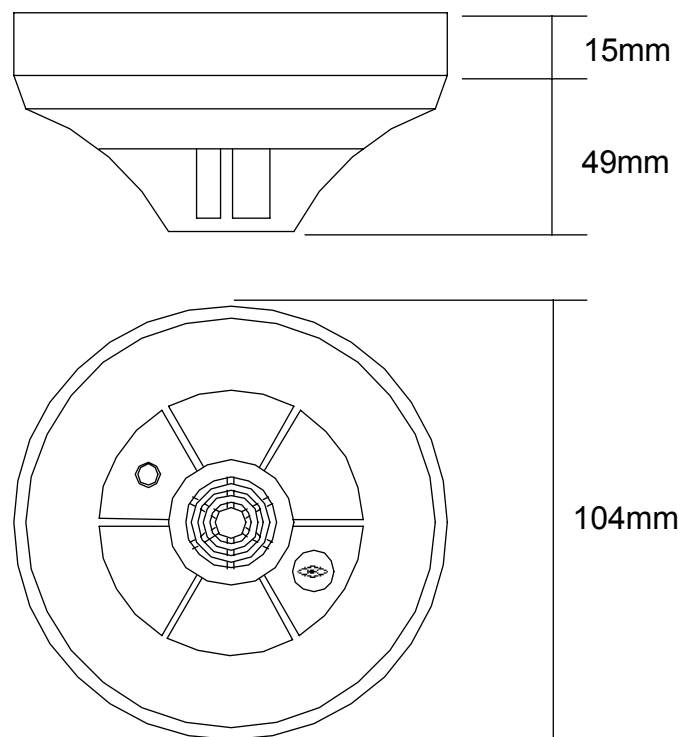

NITTAN (UK) LTD



Document No. NISM/STHA/03
Date MARCH 2001

*From world leaders in **SENSOR TECHNOLOGY**
comes **SENORTEC.....***

**ST-H-AS
ANALOGUE ADDRESSABLE
HEAT SMOKE SENSOR
INSTRUCTION MANUAL**



LPCB REF: 041a/07



Quality System Certificate No. 041
Assessed to BS EN ISO 9002

NITTAN (UK) LTD.
Hiple Street,
Old Woking,
Surrey, England,
GU22 9LQ United Kingdom

Tel: +44 (0) 1483 769555
Fax: +44 (0) 1483 756686

Web Site: www.nittan.co.uk
e-mail: sales@nittan.co.uk